

20-pin SOP (300mil) Outline Dimensions

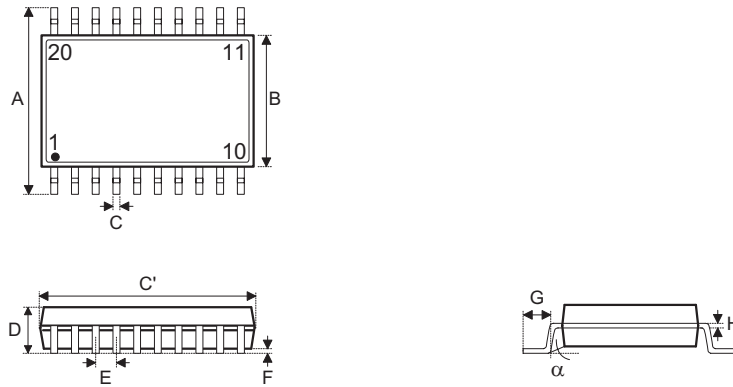

Symbol	Dimensions in inch		
	Min.	Nom.	Max.
A	0.406 BSC		
B	0.295 BSC		
C	0.012	—	0.020
C'	0.504 BSC		
D	—	—	0.104
E	0.050 BSC		
F	0.004	—	0.012
G	0.016	—	0.050
H	0.008	—	0.013
α	0°	—	8°

Symbol	Dimensions in mm		
	Min.	Nom.	Max.
A	10.30 BSC		
B	7.50 BSC		
C	0.31	—	0.51
C'	12.80 BSC		
D	—	—	2.65
E	1.27 BSC		
F	0.10	—	0.30
G	0.40	—	1.27
H	0.20	—	0.33
α	0°	—	8°